

MEPH800(8 PASSAGE+Electric)

MEPH100 slip rings, 8 passageway Pneumatic/Hydraulic, are specialized slip rings solutions, it can combine with power,signal,Ethernet,USB,Devicenet,Control Net,Canbus on request! It also could be mounted by shaft or optional flange mounting.

Connection Size:M5,G1/8",G1/4",G3/8",G1/2"

Media Types: Air/Gas, Chemical, DI / Tap Water, Oil, Water/Glycol.

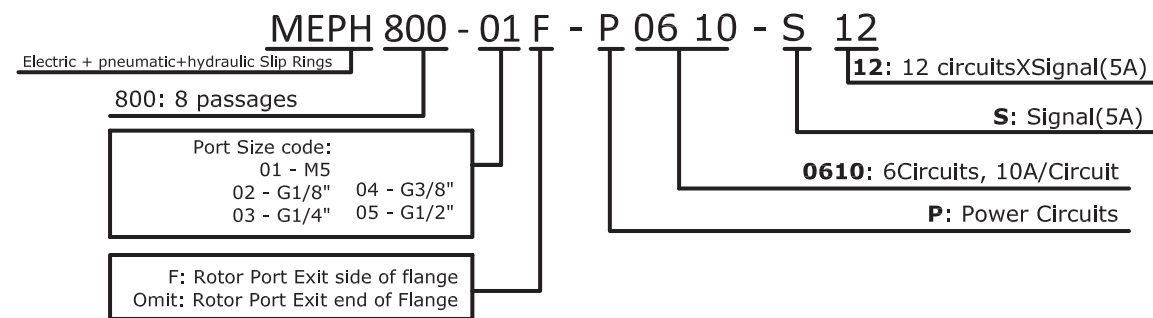

Parts# in stock

Parts#	Passage(Way)	Torque(N.m)	Passage Size
MEPH800-01	8	2.5N.m	M5
MEPH800-01F	8	2.5N.m	M5
MEPH800-02	8	4.5N.m	G 1/8"
MEPH800-02F	8	4.5N.m	G 1/8"
MEPH800-03	8	6N.m	G 1/4"
MEPH800-03F	8	6N.m	G 1/4"

Parts# - Combine with Electricl Circuits

Parts#	Passage(Way)	10A	Signal/5A	RingNum
MEPH800-XXX	8	0	0	0
MEPH800-XXX-S06	8	0	6	6
MEPH800-XXX-P0610	8	6	0	6
MEPH800-XXX-S12	8	0	12	12
MEPH800-XXX-P0610-S06	8	6	6	12
MEPH800-XXX-P1210	8	12	0	12
MEPH800-XXX-S18	8	0	18	18
MEPH800-XXX-P0610-S12	8	6	12	18
MEPH800-XXX-P1210-S06	8	12	6	18
MEPH800-XXX-P1810	8	18	0	18
MEPH800-XXX-S24	8	0	24	24
MEPH800-XXX-P0610-S18	8	6	18	24
MEPH800-XXX-P1210-S12	8	12	12	24
MEPH800-XXX-P1810-S06	8	18	6	24
MEPH800-XXX-P2410	8	24	0	24
MEPH800-XXX-S30	8	0	30	30
MEPH800-XXX-S36	8	0	36	36
MEPH800-XXX-S48	8	0	48	48
MEPH800-XXX-S60	8	0	60	60
MEPH800-XXX-S72	8	0	72	72

Specifications

Rotary Joints Specifications

PassageWay	8	Max Pressure	1500PSI(100BAR)
Max. Vacuum	10HG	Max Speed	500RPM
Material Type	Aluminum	Temperature	-40° C to 105° C

Electrical Specifications

Rating voltage	600 VDC/VAC	Contact material	Precious Metal:Gold-Gold
Dielectric strength	1000VDC@50Hz	Lead Wire	UL Teflon®
Insulation resistance	1000MΩ@600VDC	Lead Lengths	250mm
Operating Temp.	-40°C to 80°C	Protection	IP51
Mechanical vibratio	MIL-SID-810E	Humidity	10% to 90% RH
Materials	Lead Free,RoHS compliant	CE Certified	YES

Drawings